

DC Fan



60×60×15 mm

San Ace 60 9GA type Low Power Consumption Fan

General Specifications

- Material Frame: Plastic (Flammability: UL 94V-0), Impeller: Plastic (Flammability: UL 94V-0)
- Expected life See the table below. (L10 life: 90% survival rate for continuous operation in free air at 60°C, rated voltage)
Expected life at 40°C is for reference only.
- Motor protection function Locked rotor burnout protection, Reverse polarity protection
For details, please refer to p. 573.
- Dielectric strength 50/60 Hz, 500 VAC, for 1 minute (between lead wire conductors and frame)
- Insulation resistance 10 MΩ or more with a 500 VDC megger (between lead wire conductors and frame)
- Sound pressure level (SPL) At 1 m away from the air inlet
- Storage temperature -30 to +70°C (Non-condensing)
- Lead wire ⊕Red ⊖Black (Sensor) Yellow (Control) Brown
(For models without PWM control function, there is no speed control wiring.)
- Mass 50 g

Specifications

The models listed below **have ribs and pulse sensors with PWM control function.**

Model no.	Rated voltage [V]	Operating voltage range [V]	PWM duty cycle [%]	Rated current [A]	Rated input [W]	Rated speed [min ⁻¹]	Max. airflow [m ³ /min] [CFM]	Max. static pressure [Pa] [inchH ₂ O]	SPL [dB (A)]	Operating temperature [°C]	Expected life [h]
» 9GA0612P7G01	12	10.2 to 13.8	100	0.16	1.92	5900	0.68 24	80 0.32	38	-20 to +70	40000/60°C (70000/40°C)
			0	0.05	0.6	1500	0.17 6.0	5.2 0.02	10		
» 9GA0612P7H01			100	0.1	1.2	4900	0.56 19.7	55.6 0.223	34		
			0	0.03	0.36	1300	0.15 5.3	3.9 0.015	8		
» 9GA0624P7G01	24	20.4 to 27.6	100	0.08	1.92	5900	0.68 24.0	80 0.32	38		

* PWM input frequency is 25 kHz; models without specifications at 0% PWM duty cycle have zero fan speed at 0%.

The following sensor and control options are available for selection.

Available for all models. **Without sensor**

Differs according to the model. Refer to the table on p. 603. **Pulse sensor** **Lock sensor**

The models listed below **have ribs and pulse sensors.**

Model no.	Rated voltage [V]	Operating voltage range [V]	Rated current [A]	Rated input [W]	Rated speed [min ⁻¹]	Max. airflow [m ³ /min] [CFM]	Max. static pressure [Pa] [inchH ₂ O]	SPL [dB (A)]	Operating temperature [°C]	Expected life [h]
» 9GA0612G701	12	6 to 13.8	0.16	1.92	5900	0.68 24	80 0.32	38	-20 to +70	40000/60°C (70000/40°C)
» 9GA0612H701			0.1	1.2	4900	0.56 19.7	55.6 0.223	34		
» 9GA0612M701			0.08	0.96	3900	0.45 15.9	35.3 0.142	28		
» 9GA0612L701			0.03	0.36	2800	0.31 10.9	18 0.072	17		
» 9GA0624M701	24	12 to 27.6	0.05	1.2	3900	0.45 15.9	35.3 0.142	28		40000/60°C (70000/40°C)

The following sensor and control options are available for selection.

Available for all models. **Without sensor**

Differs according to the model. Refer to the table on p. 603. **Lock sensor** **PWM control**

The » mark indicates Short Lead Time Service applicable models. See p. 626 for details.

Airflow - Static Pressure Characteristics / PWM Duty - Speed Characteristics Example

9GA0612P7G01 With pulse sensor with PWM control function

PWM duty cycle

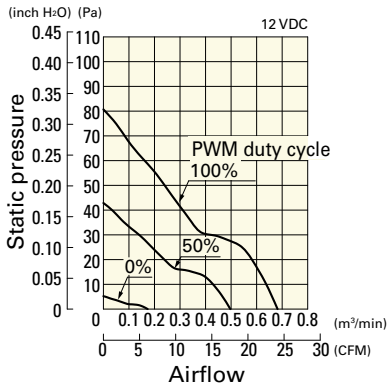

Operating voltage range

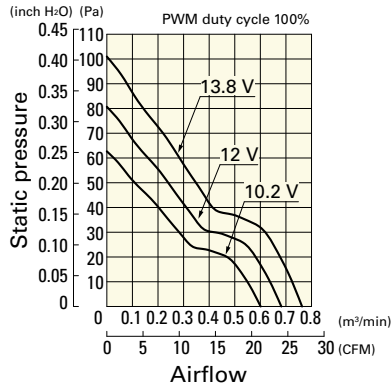

PWM duty - Speed characteristics example

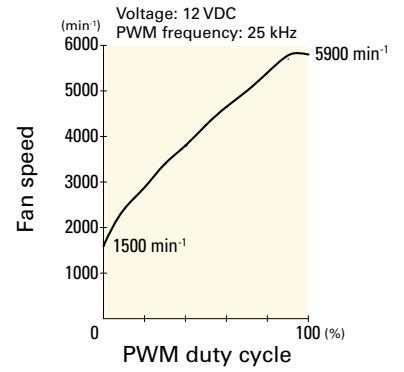

9GA0612P7H01 With pulse sensor with PWM control function

PWM duty cycle

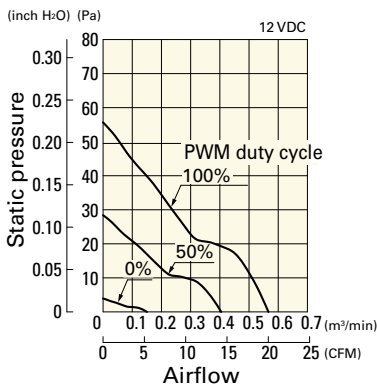

Operating voltage range

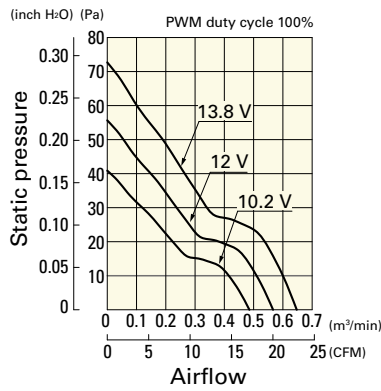

PWM duty - Speed characteristics example

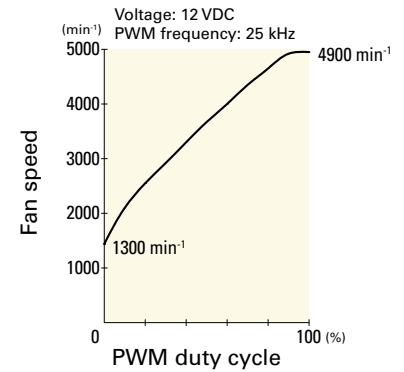

9GA0624P7G01 With pulse sensor with PWM control function

PWM duty cycle

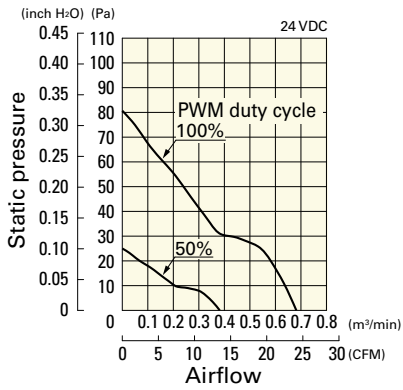

Operating voltage range

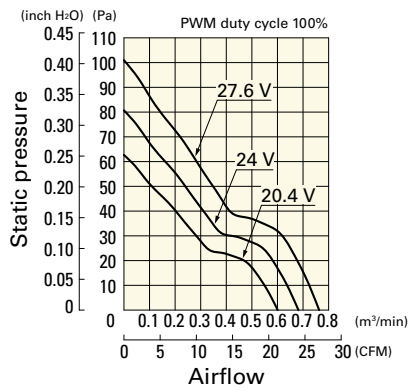

PWM duty - Speed characteristics example

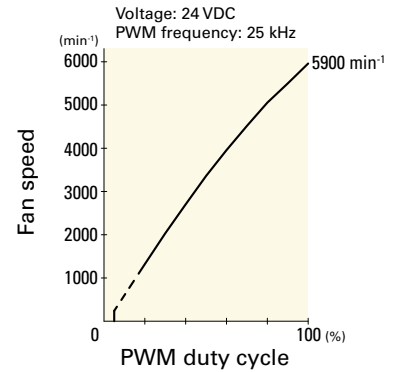

Airflow - Static Pressure Characteristics

9GA0612G701 With pulse sensor

Operating voltage range

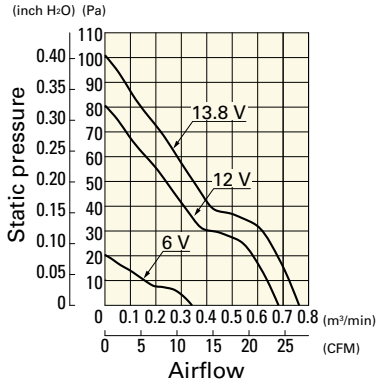

9GA0612H701 With pulse sensor

Operating voltage range

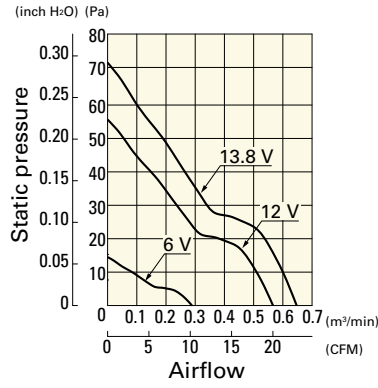

9GA0612M701 With pulse sensor

Operating voltage range

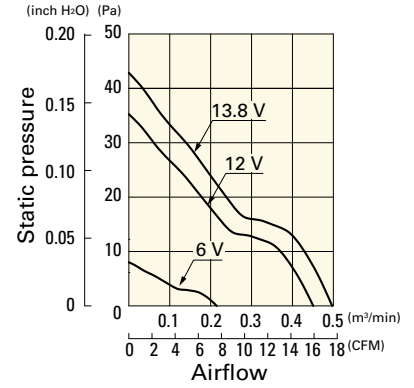

9GA0612L701 With pulse sensor

Operating voltage range

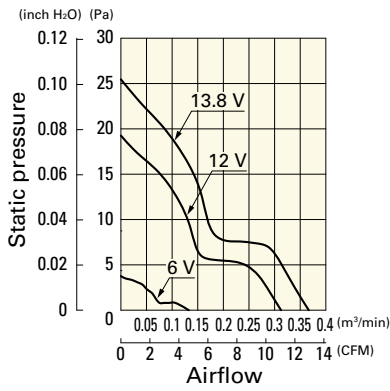

9GA0624M701 With pulse sensor

Operating voltage range

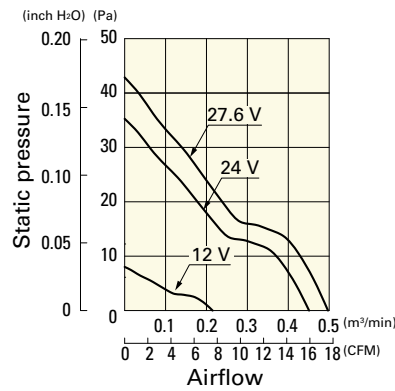

Dimensions (unit: mm) (With pulse sensor with PWM control function)

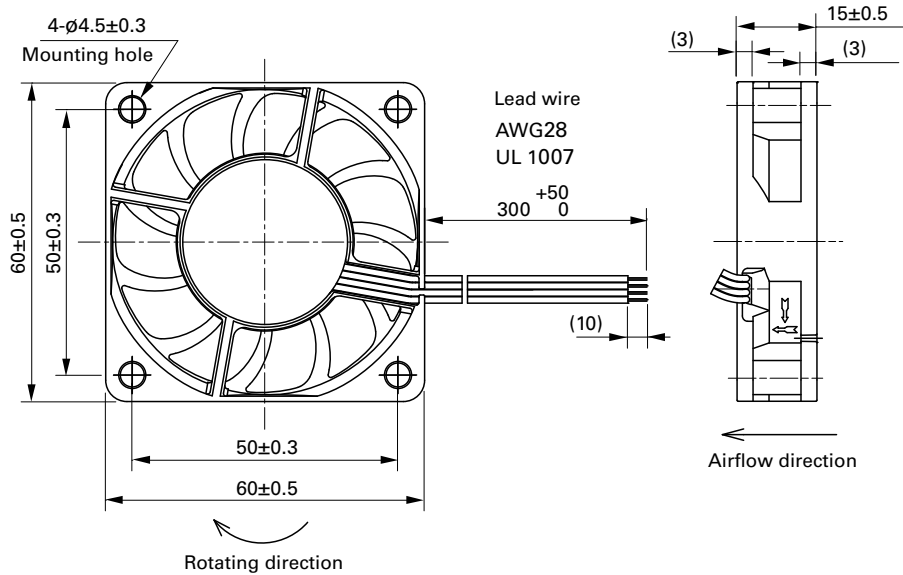

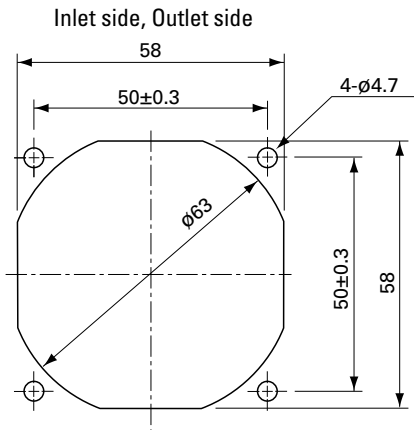
Reference Dimensions of Mounting Holes and Vent Opening (unit: mm)**Options****Finger guards**

page: p. 558

Model no.: 109-139E, 109-139H

Resin finger guards

page: p. 565

Model no.: 109-1003G

Resin filter kits

page: p. 566

Model no.: 109-1003F13 (13PPI), 109-1003F20 (20PPI),
109-1003F30 (30PPI), 109-1003F40 (40PPI)